



Low Voltage System



## STEP Warmfloor® Installation Manual

Step Warmfloor® Electric Radiant  
Floor Heating System



# Contents

---

- HEATING SYSTEM ..... 3
  - PRODUCT SPECIFICATIONS ..... 3
  - DESIGN AND CALCULATIONS ..... 3
  - SUPPLIED PARTS ..... 4
- INSTALLATION GUIDELINES ..... 5
  - WARNING ..... 5
- DESIGN AND CALCULATION ..... 6
  - HEATING NEEDS ..... 6
    - PRIMARY HEAT ..... 6
    - COMPLIMENTARY HEAT ..... 6
    - FLOOR WARMING ..... 6
  - LAYOUT AND DESIGN ..... 7
    - RECOMMENDED SPACING ..... 7
    - ROOM LAYOUT AND ELEMENT STRIPS ..... 7
    - ELEMENT TYPE AND WATTAGE ..... 8
    - AC POWER SUPPLY ..... 8
    - DC CONTROLLER ..... 9
    - WIRE GAUGE CHART ..... 9
  - CONTROL OPTIONS ..... 10
    - LOW VOLTAGE STEP TOUCH THERMOSTAT ..... 10
- ELECTRICAL GUIDELINES ..... 11
  - LOW VOLTAGE ELECTRIC RADIANT HEATING EQUIPMENT ..... 11
- FLOORING INSTALLATION OPTIONS ..... 12
- INSTALLATION ..... 13
  - STEP 1 - POSITIONING THE ELEMENTS ..... 13
  - STEP 2 - CONNECTING THE WIRES TO THE ELEMENT ..... 15
  - STEP 3 - ROUTING THE WIRES ..... 16
    - WIRING OPTIONS ..... 17
    - FAIL SAFE WIRING ..... 18
  - STEP 4 - CONNECTING THE ELEMENTS TO THE POWER SUPPLY ..... 19
- POWER SUPPLY ..... 20
  - AC POWER SUPPLY WIRING DIAGRAM ..... 20
  - DC CONROLLER WIRING DIAGRAM ..... 22
- STEP TOUCH® ..... 24
  - THERMOSTAT AND EXTERNAL SENSOR ..... 24
- FINISH FLOORING ..... 25
  - LEVELING AND COVERING THE FLOOR ..... 25
- WARRANTY REGISTRATION AND COVERAGE ..... 26
  - WARRANTY REGISTRATION CARD ..... 27
- TROUBLESHOOTING ..... 30
  - POWER SUPPLY ..... 30
  - HEATING ELEMENTS ..... 31



## HEATING SYSTEM

---

### PRODUCT SPECIFICATIONS

- STEP Warmfloor® is a 24V AC/DC, flat, flexible and thin heating element.
- The heating element can be cut to length at the jobsite.
- The element can be stapled/nailed without affecting the conductivity (do not penetrate the two conductors on each side).
- The element can easily be bent 90 degrees to fit any contour.
- The element is strong and has no failure rate during installation.
- STEP Warmfloor® can be used under almost any flooring including tile, stone, wood, laminate, resilient and carpet.
- The system is ideal for both renovation and new construction.
- No room is too small or too large to be heated with STEP Warmfloor®.
- Because the product is thin, 3/64" (1.2mm), it can be installed without changing the height of molding, doors or cabinets.
- The system is designed to simplify the individual control of each room.
- STEP Warmfloor® has the ability to self-regulate - as the material gets warmer, less electricity passes through the polymer - therefore it is extremely energy-efficient.
- The element acts on its whole surface as a sensor and cannot overheat.
- This heating system is very versatile and can be used for residential and commercial applications. From taking away the chill of cold floors to keeping free of ice and snow driveways and more.
- This unique Nano technology has been around for over 30 years.
- If it needs heating STEP Warmfloor® has the solution.

### DESIGN AND CALCULATIONS

- The installation shall be calculated and a layout made to determine the materials required.
- The more specific the layout the easier will be the installation. Indicate for each area:
  - Exact room measurements and fixed fittings.
  - Placement and number of strips of elements.
  - Length and wattage per element strip.
  - Measured available supply voltage.
  - Location of power source, including electrical box, control(s) and power supply(s).
  - Wire size and length according to load and distance to the power source.
  - Size of power supply or DC controller.
  - Load distribution on the interface board(s).

## HEATING SYSTEM

---

### SUPPLIED PARTS



#### STEP® Heating Element

EP-30-25W-24V  
EP-30-29W-24V  
EP-30-36W-24V  
EP-23-22W-24V



#### STEP® AC Power Supply

EPI-LX-R-250W-24V  
EPI-LX-R-500W-24V  
EPI-LX-R-100W-24V  
EPI-LX-R-1500W-24V



#### STEP® DC Controller

EPI-DC-M1	EPI-DC-M5
EPI-DC-M2	EPI-DC-M6
EPI-DC-M3	EPI-DC-M7
EPI-DC-M4	EPI-DC-M8



#### STEP® C&T Kit (10)

Connectors (tinned copper)  
Sealant Tape



#### Extension Wire

Tcu 12AWG or Tcu10AWG  
Stranded tinned copper



#### STEP® T-BLOCK

Terminal Board  
2-Bar tinned copper



#### STEP® TOOL-PRO

Recommended crimp  
Tool for connectors



#### Signal Wire (3-Con)

From thermostat to  
AC or DC Controller



#### STEP Touch®

EPI-LX-TC – Thermostat  
EPI-LX-TS – External  
Sensor

## **INSTALLATION GUIDELINES**

---

### **BEFORE STARTING**

- The more efficient the building, the more efficient will be the STEP® heating system.
- Thermal insulation is required under the heating elements to push the heat where it is needed. Remember that hot goes to cold, equally in all directions.
- The heating elements can be installed on any dry, clean, non-conductive, and structurally sound surface.
- Floor temperature should be at least 65°F (18°C) when installing the elements.
- Choose qualified personnel who are familiar with the STEP Warmfloor® heating system.
- This is an electric heating system and requires trained personnel in the National Electrical Code that understands the importance of preventing mistakes that can cause an electrical fire.
- The installation shall be made in accordance with local codes, ordinances, trade practices, and manufacturers' instructions.
- Make sure that all materials used are approved for the specific application and have no adverse compatibility with the heating elements.
- Use only components recommended by the manufacturer.
- Read and follow the installation instructions to assure having the best satisfaction for a comfortable and energy efficient heating system.
- STEP® Labels shall be provided with the heating product and should be filled out and affixed in the place indicated:
  - CAUTION label is to be attached to the junction box.
  - WARNING label is to be attached to the service panel.

### **WARNING**

- HEATING ELEMENTS SHOULD NOT TOUCH, CROSS OR OVERLAP AT ANY POINT.
- DO NOT ALLOW EXTENSION WIRES TO CROSS ONE ANOTHER OR THE HEATING ELEMENT.
- DO NOT USE PIERCED OR DAMAGED HEATING ELEMENT.
- DO NOT PUT NAIL, STAPLE OR ANY METALLIC OBJECT THROUGH TERMINALS AND BUS BRAIDS.
- HEATING ELEMENT IS REQUIRED TO BE INSTALLED BY QUALIFIED PERSONNEL IN ACCORDANCE WITH LOCAL AND NATIONAL CODES SUCH AS NEC IN U.S., CEC IN CANADA.
- HEATING ELEMENTS SHOULD BE TESTED AND MEASURED BEFORE BEING COVERED.
- READ AND FOLLOW ALL INSTRUCTIONS.



## DESIGN AND CALCULATION

---

### HEATING NEEDS

Decide on the application of the floor heating system before starting design and calculations. The calculations should take into considerations:

- Heating required; primary heat, complementary heat, or floor warming.
- Outside average temperature, insulation values and room size.
- Additions and conservatories may need to be calculated according to usage and construction.

### PRIMARY HEAT

For primary heating a heat loss calculation is required. This can be done per room or for the whole house. STEP Warmfloor® provides services for project specific heat loss calculations.

- Perform a heat loss calculation to identify the wattage needed to heat the area to the required temperature in your location.
- You will need to know the type of construction, the measurements and insulation values of the floor, ceiling and walls (including windows and doors).
- Design the spacing between the elements and/or use an element type with higher wattage to get the necessary wattage.

### COMPLIMENTARY HEAT

- When used as a complementary heat source it shall provide a gentle and even under floor heating experience in addition to the existing heating system in the house.
- Use an external sensor to avoid competing with thermostats from other heat sources.

### FLOOR WARMING

Floor warming systems take the chill out of cold floors, but are not designed to be the primary heat source. Typically a floor warming system is installed in the bathroom and underneath tiles in the kitchen, hallway or other areas where you want the comfort of under floor heat.

- For floor warming evaluate the needs for each area: room type; available open floor space and floor covering.
- Bathrooms may require more heat and this can be achieved by selecting heating elements with a higher wattage or placing elements under tubs or shower pans, in walls or behind mirrors.
- An external sensor is recommended to maintain the adequate floor temperature.

**NOTE:** For health reasons floor surface temperature should not exceed 85°F (29°C)

## DESIGN AND CALCULATION

---

### LAYOUT AND DESIGN

#### RECOMMENDED SPACING

Maximum recommended spacing between strips of elements:

Ceramic tile, natural stone, resilient	2 - 3 inches	5 - 7.5 cm
Hardwood, laminate	2 - 5 inches	5 - 13 cm
Carpet	2 - 8 inches	5 - 20 cm

When the heating needs are less than 3.5 W/sqft. (38 W/m<sup>2</sup>), plan the distribution so that the strips of elements do not exceed the recommended spacing to avoid uneven temperatures (i.e., cold spots between the strips of elements).

#### ROOM LAYOUT AND ELEMENT STRIPS

Measure the room(s) and create a drawing of the area to be heated. Make sure to draw in any fixed fixtures and other areas where heating is not to be installed.

#### ***Position elements, thermostat and power supplies***

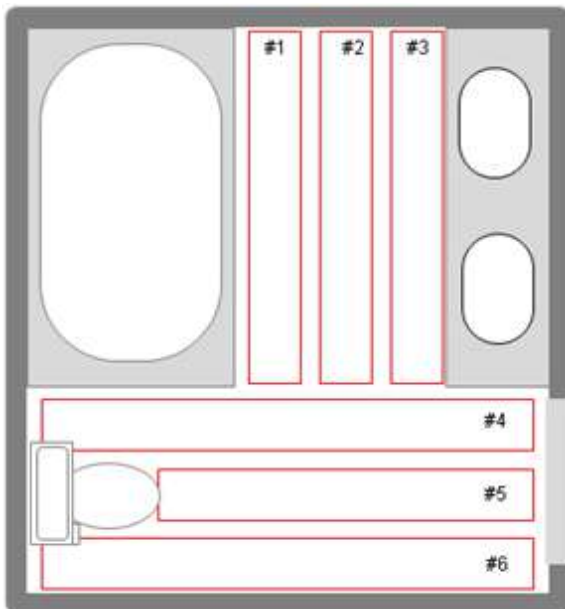

Position the elements in the most convenient direction to have as few strips as possible taking in consideration where the wires will be connected.

- 1) Make sure to place elements close, in front of the vanity, tub and toilette.
- 2) In narrow areas where the distance between the strips is more than the recommended spacing consider:
  - a. changing direction of the elements
  - b. adding more distance between the wall and the first element
  - c. using 9" wide elements
- 3) Indicate number and length of each strip.
- 4) Position the thermostat on an interior wall away from windows, doors and other areas with draft.
- 5) The power supply must be installed in a well-ventilated area in accordance with Article 450 of the National Electric Code. Provide sufficient clearance for free flow of air to allow adequate cooling and to eliminate fire hazard. Keep delicate and flammable materials away from the power supply enclosure.

**NOTE:** Make sure to always place element strips perpendicular to hardwood and engineered floors.

## DESIGN AND CALCULATION

### ELEMENT TYPE AND WATTAGE

The default heating element for floor warming projects and most primary heating projects is EP-30-25W (STEP Residential™). Installing heating elements with substantially higher wattage than needed will make the system more reliant on a thermostat and thereby decrease energy efficiency.

Choose the appropriate heating element according to the heating needs, available open floor space to be heated and floor covering. Elements must be connected in parallel.

ELEMENT DATA at 24 VOLTS @ 68°F					INSTALLATION DATA						
Element Type		Ohms /ft	Linear W/ft	Density W/sqft	Max. length @ 450W in feet	Element spacing and wattage per sqft					
Width	Model					2"	3"	4"	5"	8"	12"
9"	EP-23-22W	85	6.8	9.0	66	7.7	7.2	6.8	6.3	5.4	4.5
9"	EP-23-36W*	52	11.0	14.6	41	12.4	11.7	11.0	10.2	8.8	7.3
12"	EP-30-15W	124	4.6	4.6	98	3.9	3.7	3.5	3.2	2.8	2.3
12"	EP-30-25W	74	7.8	7.8	57	6.6	6.2	5.9	5.5	4.7	3.9
12"	EP-30-29W	64	9.0	9.0	50	7.7	7.2	6.8	6.3	5.4	4.5
12"	EP-30-36W*	52	11.0	11.0	41	9.4	8.8	8.3	7.7	6.6	5.5

Table: Element type and wattage

\* Floor covering limited to concrete, tile or stone

### AC POWER SUPPLY

The EPI-LX and EPI-LX-R power supply series consist of one 250W or of one to three 500W circuits.

- Designed wattage per circuit is 90%, or 225 watts and 450 watts.
- Do not exceed the maximum element length as indicated in the chart "Element Type and Wattage".
- Combine element strips from the layout to optimize distribution for each 225 watts or 450 watts circuit in the power supply.

POWER SUPPLY	DIMENSIONS			PRIMARY CIRCUIT BREAKER			SECONDARY CIRCUIT BREAKER
	Transformer Type	Height (inch)	Width (inch)	Depth (inch)	120 VAC	208 VAC	230 VAC
EPI-LX-250W	7.4	7.0	3.5	5A		2.5A	1 x 15A
EPI-LX-500W	11.0	7.0	3.5	10A	5A	5A	1 x 25A
EPI-LX-R-250W	11.9	7.0	3.5	5A		2.5A	1 x 15A
EPI-LX-R-500W	14.4	7.0	3.5	10A	5A	5A	1 x 25A
EPI-LX-R-1000W	22.4	7.0	3.5	15A	10A	10A	2 x 25A
EPI-LX-R-1500W	28.4	7.0	3.5	20A	15A	15A	3 x 25A



## DESIGN AND CALCULATION

### DC CONTROLLER

The DC Controller comes with one to eight channels of 500 watts.

- Designed wattage is 90 % capacity or 450 watts for each channel.
- Maximum voltage is 30V

DC CONTROLLER	DIMENSIONS			CHANNELS	INPUT VOLTAGE	OUTPUT CIRCUIT BREAKER	
Model	Height (inch)	Width (inch)	Length (inch)	No. off	Volts	Typical Operating Current	Amperage per Channel
EPI-DC-M1	2.780	8.720	2.795	1	20 – 30 VDC	1 x 20A	1 x 25A
EPI-DC-M2	2.780	8.720	4.085	2	20 – 30 VDC	2 X 20A	2 x 25A
EPI-DC-M3	2.780	8.720	5.375	3	20 – 30 VDC	3 x 20A	3 x 25A
EPI-DC-M4	2.780	8.720	6.665	4	20 – 30 VDC	4 x 20A	4 x 25A
EPI-DC-M5	2.780	8.720	7.955	5	20 – 30 VDC	5 x 20A	5 x 25A
EPI-DC-M6	2.780	8.720	9.245	6	20 – 30 VDC	6 x 20A	6 x 25A
EPI-DC-M7	2.780	8.720	10.535	7	20 – 30 VDC	7 x 20A	7 x 25A
EPI-DC-M8	2.780	8.720	11.825	8	20 – 30 VDC	8 x 20A	8 x 25A

### WIRE GAUGE CHART

Minimize voltage drop by planning the wire runs as short as possible. Use larger wire gauge for more power output.

Refer to the following chart for maximum secondary wire length, both wires included, per circuit in feet.

Power Watts	Wire Gauge and Wire Length (feet)					
	14 AWG	12 AWG	10 AWG	8 AWG	6 AWG	4 AWG
60 VA	40	63	100	159	252	401
90 VA	27	42	67	106	168	268
120 VA	20	32	50	80	126	201
150 VA	16	26	40	64	101	161
180 VA	14	21	34	53	84	134
210 VA	12	18	29	46	72	115
240 VA	10	16	25	40	63	101
270 VA	9	14	23	36	56	90
300 VA	8	13	20	32	51	81
330 VA	8	12	19	29	46	73
360 VA	7	11	17	27	42	67
390 VA	7	10	16	25	39	62
420 VA	6	9	15	23	36	58
450 VA	6	9	14	22	34	54

## DESIGN AND CALCULATION

---

### CONTROL OPTIONS

The STEP Warmfloor® heating elements are self-regulating and therefore act as a sensor over the whole floor surface. Although the heating system does not require a control unit, except for an on/off switch, it is highly recommended to install a thermostat.

To ensure long life and maximum efficiency, use only recommended controls for the EPI-LX and EPI-LX-R power supply series or for the DC Controller.

### LOW VOLTAGE STEP TOUCH THERMOSTAT

The EPI-LX-TC, thermostat can be used in conjunction with all the EPI-LX-R power supply series.

- Install the thermostat on an interior wall and away from the sun rays and drafts.
- Measure the distance from the power supply to the thermostat to identify the length of the thermostat signal wire.

The low-voltage (24V) thermostat is connected to the power supply using a 3-conductor cable and can control up to 20 power supplies.

The thermostat has the following features:

- Ambient mode:      ► controls and displays the ambient air temperature
- Floor mode:        ► controls and displays the floor temperature using an external temperature sensor (EPI-LX-TS)

### EXTERNAL SENSOR

When installing complementary heating or floor warming, use the external sensor to measure the floor temperature. This will keep the STEP Touch thermostat from competing with thermostats from other heat sources. The external sensor is installed in the floor and should not touch the elements.

The EPI-LX-TS thermostat maximizes the efficiency of the STEP Warmfloor® system by requiring the heating elements to gently replace only the heat that is lost from the zone. Temperature is measured in 15 minutes cycles by the thermostat's microprocessor, which determines the amount of pulsing needed for each subsequent interval.

### LINE VOLTAGE TIMER SWITCH

The MICRO-PROG is a programmable timer switch that can be used with the EPI-LX-250W and 500W models. The control is connected to 120V (not available in 230V) and has 2 operating modes, manual (MAN) and automatic (AUTO).

This controller is normally only used for small areas.

# **ELECTRICAL GUIDELINES**

---

## **LOW VOLTAGE ELECTRIC RADIANT HEATING EQUIPMENT**

- 1. Scope.** This installation instruction covers electric radiant heating equipment and associated components operating at  $\leq 30$  volts rms or 42 volts peak, or direct current  $\leq 60$  volts.
  
- 2. Low Voltage Heating Equipment.**
  - (A) **General.** A low voltage heating system shall consist of a low voltage isolating power supply, heating elements, and associated components that are all identified for the use. The output circuits of the power supply are rated for 25 amperes maximum and operate at 30 volts (42.4 volts peak) ac maximum or 60 volts dc maximum under all load conditions.
  
  - (B) **Class 2.** Listed Class 2 equipment shall be rated in conformance with Chapter 9, Table 11(A) or Table 11(B).
  
  - (C) **Alternate Energy Sources.** Listed low voltage heating equipment shall be permitted to be supplied directly from an alternate energy source such as solar photovoltaic (PV) or wind power. When supplied from such a source, the source and any power conversion equipment between the source and the heating equipment and its supply, shall be listed and comply with the applicable section of the NEC for the source used.
  
- 3. Listing Required.** Low voltage heating systems shall comply with (A) and (B).
  - (A) **Listed System.** Low voltage heating systems shall be listed as a complete system. The heating portion of the product, power supply, interconnecting wiring, and fittings shall be listed for the use as part of the same identified heating system.
  
  - (B) **Assembly of Listed Parts.** The listed system and approved system components shall be installed in accordance with the low voltage heating product manufacturer's instructions.
  
- 4. Low Voltage Circuits.**
  - (A) **Ground.** Secondary circuits shall not be grounded.
  
  - (B) **Isolation.** The secondary circuit shall be insulated from the branch circuit by an isolating transformer, provided as part of the listed assembly.
  
- 5. Provisions.**
  - (A) **Fixed Electric Space Heating Equipment.** Installation shall be made in accordance with NEC 424, Chapter V, Electric Space Heating Cables, or Chapter IX, Electric Radiant Heating Panels and heating Panel Sets, except as noted in 424.100-424.102.
  
  - (B) **Fixed Outdoor Electric Deicing and Snow Melting Equipment.** Installation shall be made in accordance with NEC Article 426, except as noted in 424.100-424.102.

## FLOORING INSTALLATION OPTIONS

---

### TILE – IN MORTAR

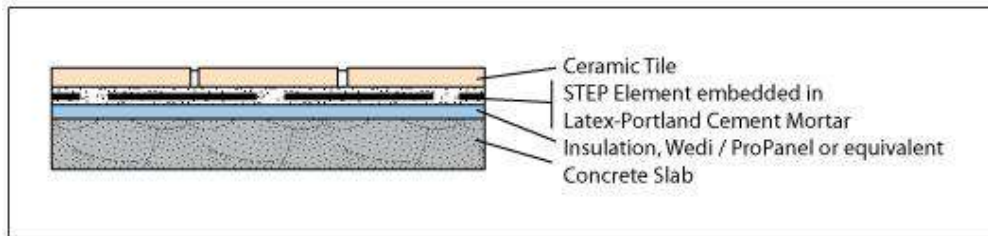

### WOOD – NAIL DOWN OR FLOATING FLOORS

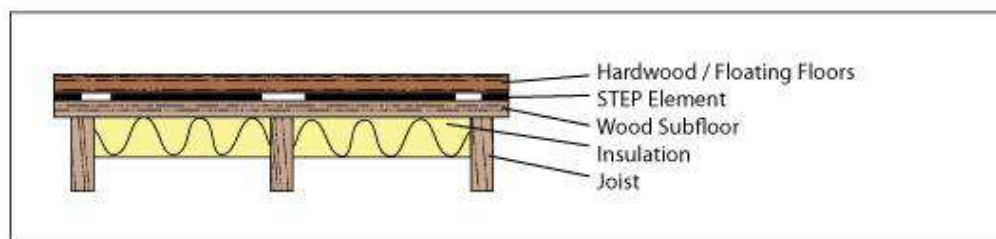

### CARPET – STRETCH-IN

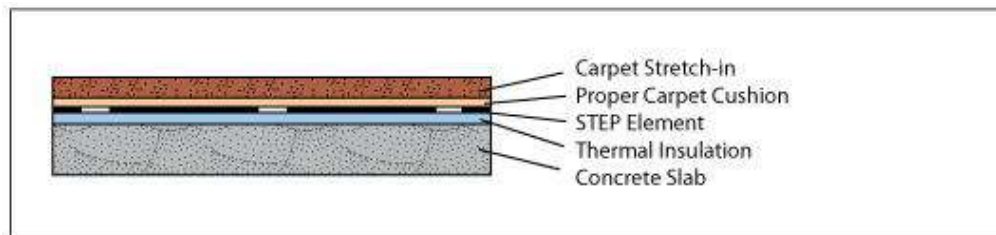

### BETWEEN JOISTS – UNDER SUBFLOOR

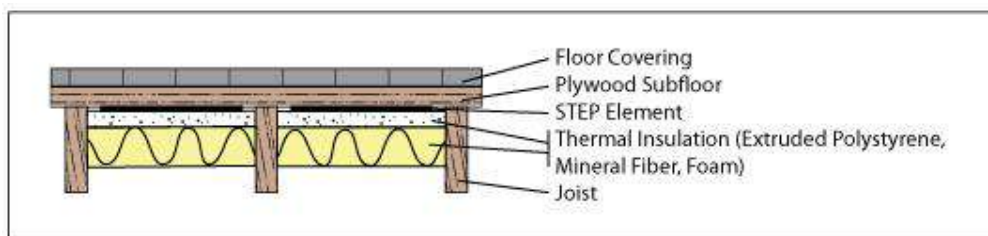

**NOTE:** View more flooring options and guidelines at [www.warmfloor.com](http://www.warmfloor.com)

## INSTALLATION

### STEP 1 - POSITIONING THE ELEMENTS

**NOTE:** The elements are held down to the subfloor with cement based mortar, latex modified thin-set, staples, or approved tape. Do not use duct tape, adhesives or premix products, unless they are approved by the manufacturer to be compatible with the heating elements.

- The heating element comes in a roll. Cut the element with a pair of scissors following the calculated design.
- Refer to Design and Calculation for the maximum length per element strip according to element type and wattage. The maximum load per strip is 450 watts.
- Where there may be a risk of damaging the bus braids refer to Fail Safe Wiring method by connecting both ends of each element strip.
- It is important to follow the layout and worksheets provided with the heating system. Should changes be made, recalculate and write down the element length and load distribution on the power supply.
- The elements shall be placed in open spaces and not underneath fixed fittings; such as bookshelves, cupboards, cabinets, etc.
- Minimum distance between elements and from plumbing fixtures is 2 inches (5 cm).
- Position elements in critical places, e.g., in front of the vanity (including toe-kick), the tub or shower and the toilet bowl.
- Choose where the wires will be connected and leave adequate spacing to route them.

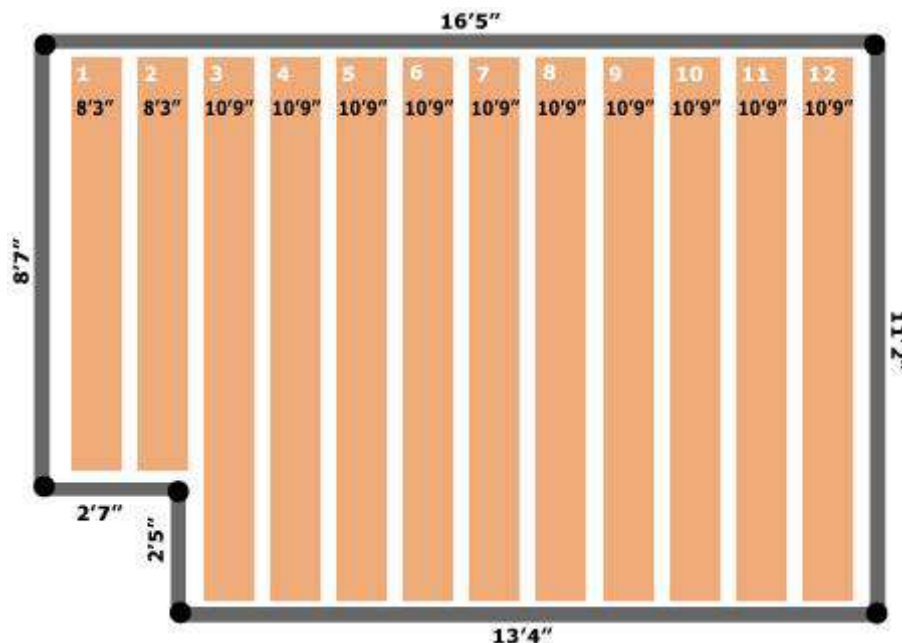

## INSTALLATION

---

- The extension wires can be connected on the floor, up the wall under the baseboard, or in raised foundation, under the subfloor.

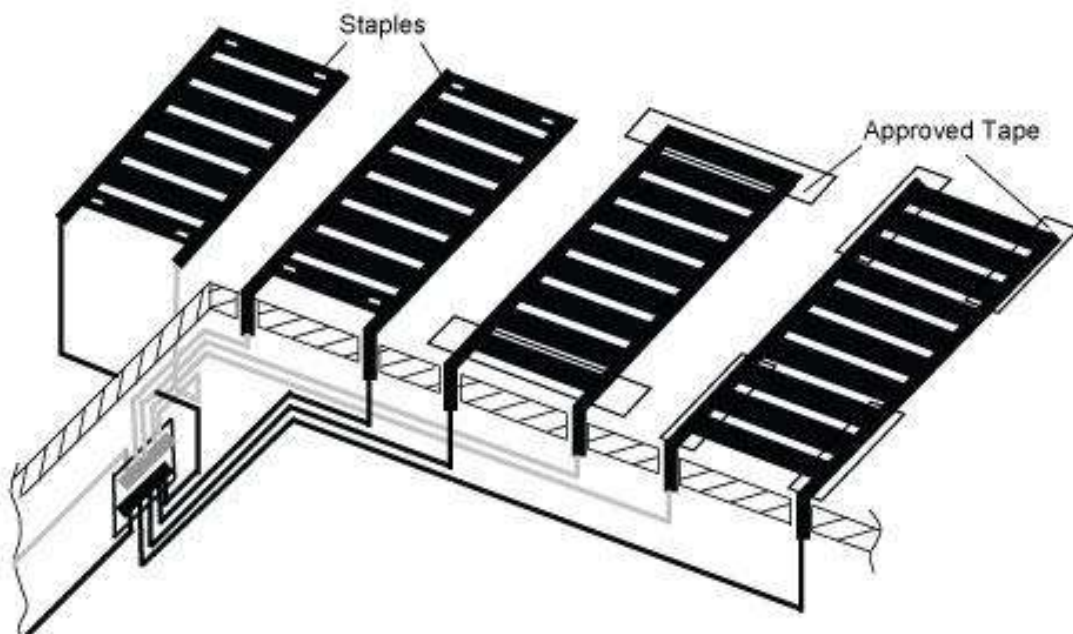

- Stretch the element in position. The elements must lay flat with no air gap.
- Secure the elements to the subfloor using staples or approved tape. Secure on one end, stretch, hold, and then secure the other end.
- **Do not** penetrate the bus braids on each side of the element.
- Connect the elements to tinned copper wires using the STEP<sup>®</sup> tool, connectors and sealant tape.
- To avoid increasing the height on the floor, use wires 14AWG or 12AWG. The maximum wire gauge on the connectors to the elements is 10AWG.
- If the power supplies are not close to the elements, instead of using larger wire gauge in the floor, or running too many or too long wires across the room, the elements can be connected to terminal blocks.
- Keep each terminal block to maximum 450 and calculate the appropriate stranded wire size to run to the PCB terminals in the power supply.
- Minimize voltage drop by planning the wire runs. For proper wiring, refer to the Wire Gauge Chart and the National Electrical Code.
- Route the wires neatly and do not overlap them or cross under or over the heating elements.

**NOTE:** You can use STEP<sup>®</sup> double-sided tape to secure the elements and keep the wires in position as you route them along the floor.



## INSTALLATION

### STEP 2 - CONNECTING THE WIRES TO THE ELEMENT

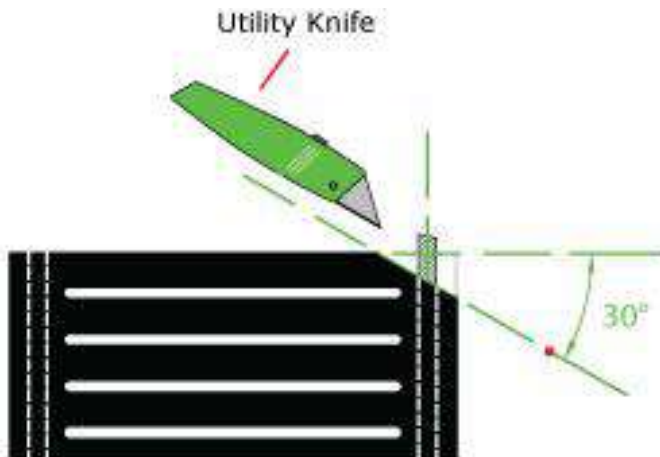

- **Expose the bus braids** by making an angled score in the plastic, front and back and along the bus braid above the score, with a utility knife. Bend the element where the cuts are made and pull off the corners to remove the surplus of plastic. **Make sure that the bus braid is not cut or damaged.** Should this occur, re-cut the element and re-strip the bus braid. Repeat on the other side.

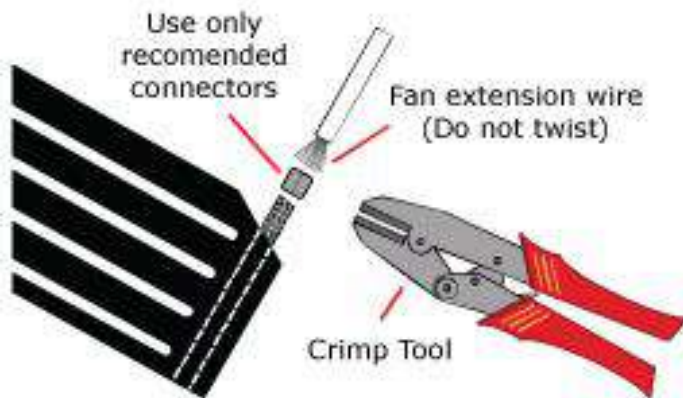

- **Connect the bus braid to an extension wire**, (PVC insulated, stranded tinned copper wire, 105°C, 300V). Refer to Wire Gauge chart. Crimp the joint using the recommended tinned copper connectors and crimp tool. Using components not recommended by the manufacturer will void the warranty.

**IMPORTANT:** Check that connections are secure.

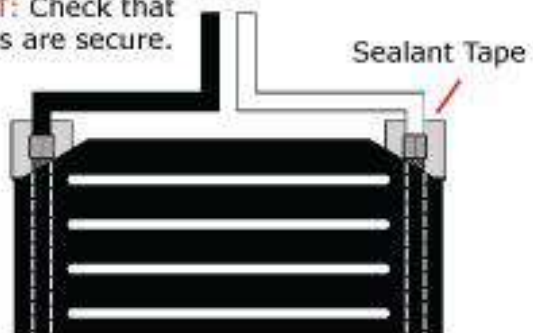

- **To differentiate the polarities supplied to the element**, use two different wire colors (e.g., red and black) and number them for future reference. Insulate the connections using the recommended sealant tape. Fold tape and press together overlapping element, connector and wire to form a flat and smooth splice.

## INSTALLATION

### STEP 3 – ROUTING THE WIRES

**IMPORTANT:** The installation shall be made in accordance to local codes and ordinances. Special wiring and/or a conduit (plastic or metal) may be required in the walls, if applicable.

- Plan circuit supply from main panel to on/off switch, control, power supply, terminal block (if applicable), and heating elements. Refer to Wiring Diagram, Power Supply Capacity, and Wire Gauge.
- Power Supply shall be placed vertical on a wall, in the ceiling, under the floor or in a closet, according to National Electrical Code in such a way that heat is dissipated effectively. Make sure that vibration is not transmitted through the wall or structure.

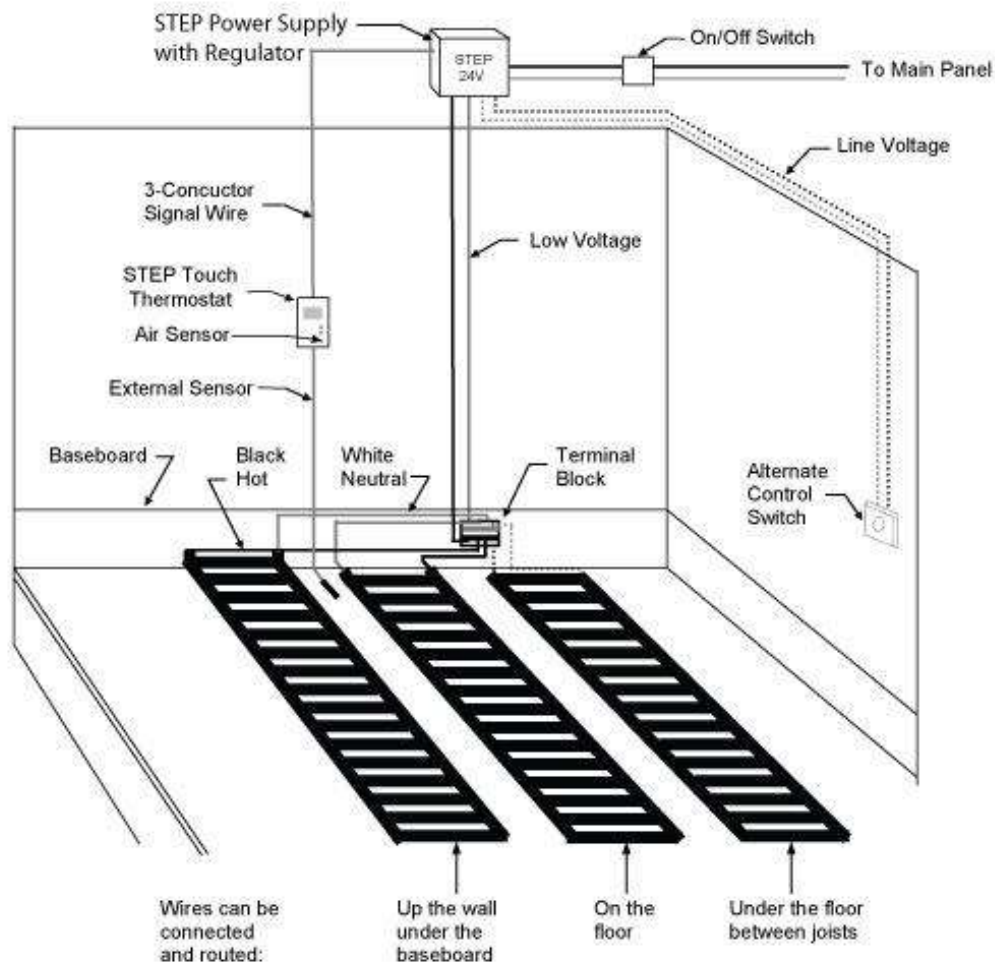

# INSTALLATION

## WIRING OPTIONS

**IMPORTANT:** Refer to Wire Gauge Chart to minimize voltage drop.

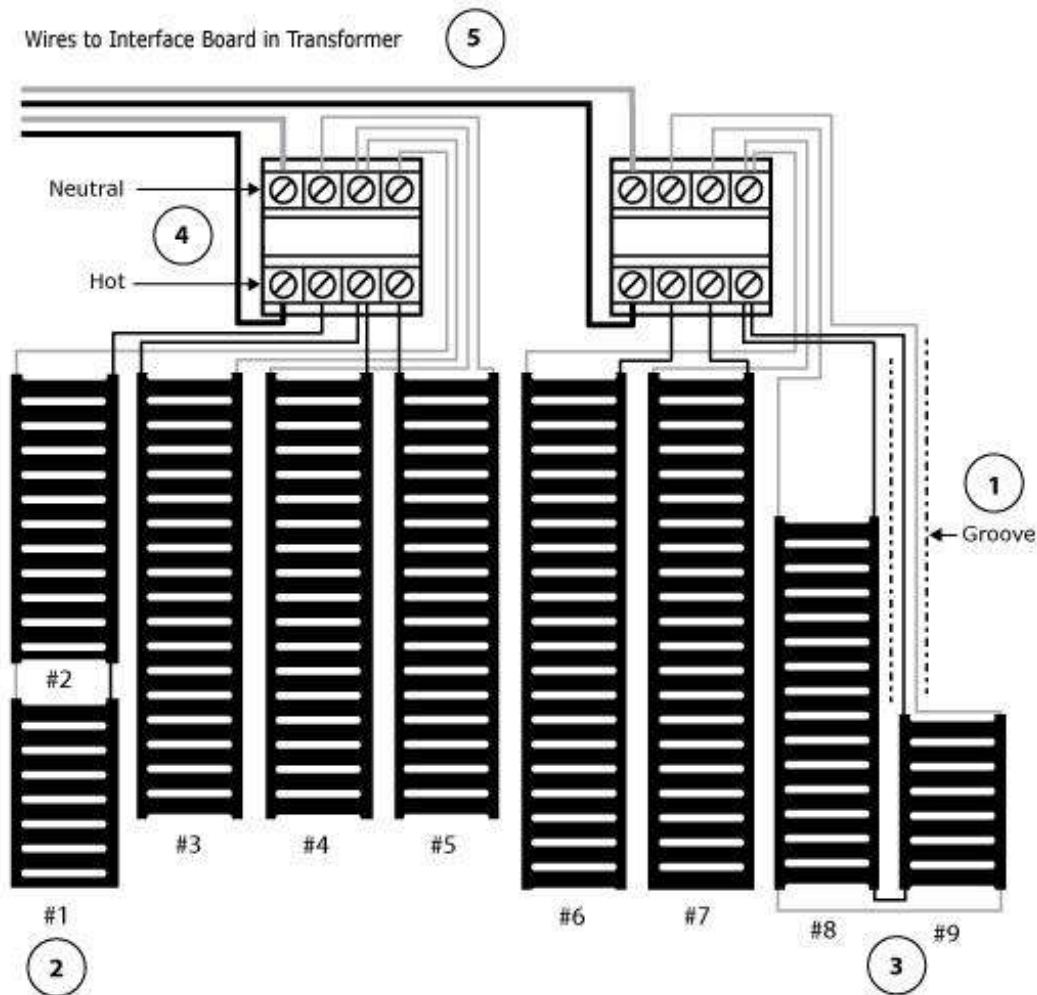

- (1) When running the wires on the floor, route them neatly and do not allow them to cross one another. Where appropriate, make a groove in the floor to protect and bury the wires. Connections and wires can also run under the floor between joists.
- (2) Elements may be linked as long as the added total length does not exceed 450W.
- (3) In some applications, fail safe wiring may be required.
- (4) Terminal block(s) may be needed if the power supply is located away from the elements, as this allows using larger wire gauge to minimize voltage drop. Connect all the <red> wires to one bus-bar and all the <black> wires to the other bus-bar. Maximum total load per terminal block is 450 watts.
- (5) The elements can be routed and connected directly to the interface board on the power supply. Distribute evenly the load from the elements to each circuit breaker.

## INSTALLATION

### FAIL SAFE WIRING

The Fail Safe Wiring method must be used for installations that are not embedded in concrete, mortar, leveling compound or under underlayment and cement boards, e.g., under carpet and carpet cushion, under the subfloor between joists, in walls, behind mirrors, etc.

Fail Safe Wiring is used wherever there may be a risk of cutting or damaging the bus braids. This method avoids creating a short.

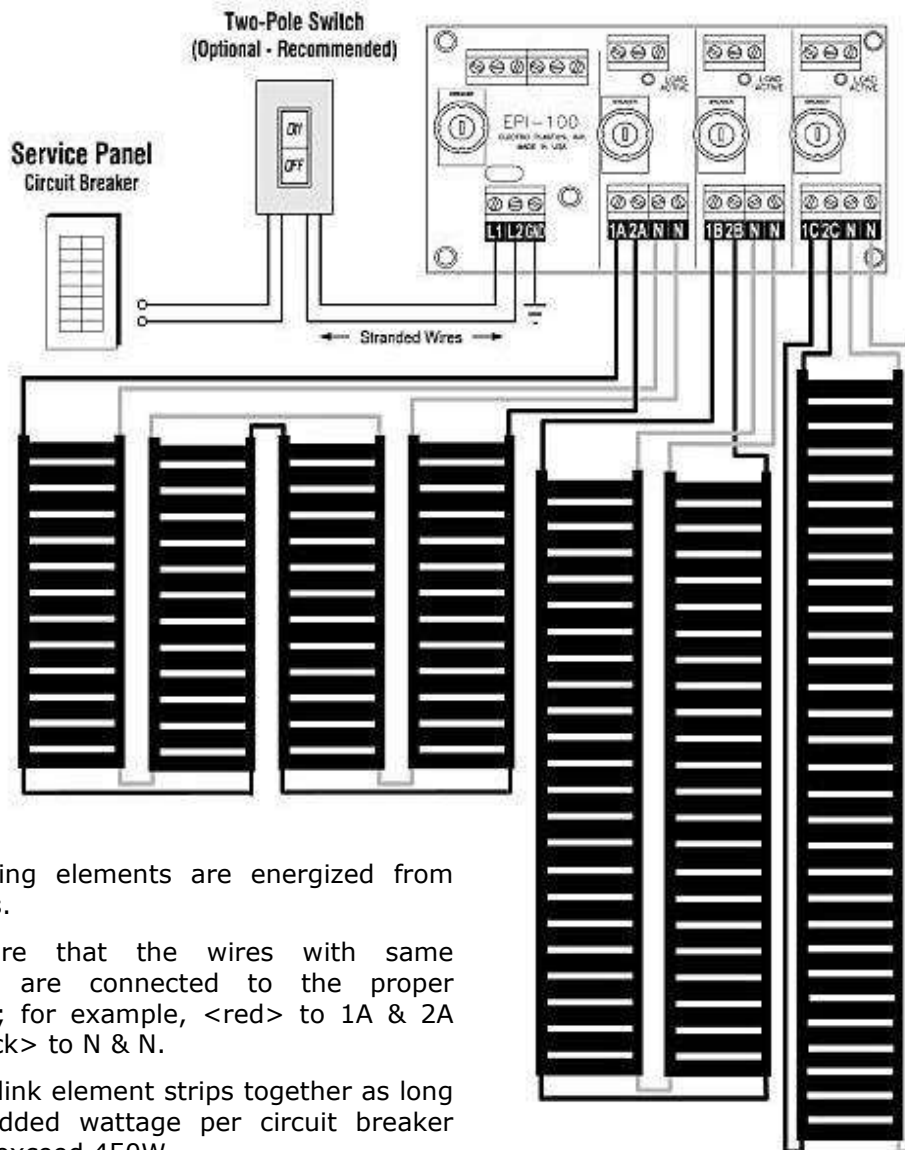

The heating elements are energized from both ends.

Make sure that the wires with same polarities are connected to the proper terminals; for example, <red> to 1A & 2A and <black> to N & N.

You may link element strips together as long as the added wattage per circuit breaker does not exceed 450W.

## **INSTALLATION**

---

### **STEP 4 – CONNECTING THE ELEMENTS TO THE POWER SUPPLY**

- Each room can have one or more power supplies and if necessary multiple terminal blocks.
- Minimize voltage drop by planning wire runs as short as possible from elements to power supply. See Wire Gauge Chart for wire size and length versus load.
- The maximum wattage, on the low voltage, per circuit breaker, is 450 watts (or 18.75 amps on 24V). For example:
  - The AC Power Supply EPI-LX-R-500W has one circuit breaker with a maximum load of 450W; EPI-LX-R-1000W has two circuit breakers, thereby two times 450W; and EPI-LX-R-1500W has three circuit breakers; thereby three times 450W.
  - The DC Controller has a Main PCB and up to 8 channels, each with a load of 450W and a circuit breaker of max. 25A. Models are: EPI-DC-M1, EPI-DC-M2, EPI-DC-M3, EPI-DC-M4, EPI-DC-M5, EPI-DC-M6, EPI-DC-M7 and EPI-DC-M8.
- If the power supply is not close to the elements, instead of using larger wire size in the floor, or running too many or too long wires across the room, the elements can be connected to terminal blocks. Keep each terminal block to maximum 450W and then calculate the appropriate wire size used to run to the power supply.
- **IMPORTANT:** Always connect elements in parallel - not in series. Connect same polarity wires together and number each element with its corresponding <red> and <black> wires to facilitate further measurements.
- A certified electrician has to measure the amperage for each heating element BEFORE being covered and the values have to be entered on the Check List form. For guidance, refer to Design & Calculation.
- Select the 24-Volt power supply(s) that has the capacity to satisfy the load of heating elements installed. Maximum load on the power supply is 90% of its total capacity. For data sheet specifications, refer to STEP<sup>®</sup> AC Power Supply or STEP<sup>®</sup> DC Controller.
- The power supply must be installed in a well-ventilated area in accordance with Article 450 of the National Electric Code. Provide sufficient clearance for free flow of air to allow adequate cooling and to eliminate fire hazard. Keep delicate and flammable materials away from the power supply enclosure.
- Choose the appropriate control for the application. For data sheet specifications, see Control Options.
- STEP Warmfloor<sup>®</sup> Labels shall be provided with the heating product. The following labels should be filled out and affixed in the place indicated:
  - Serial Number label comes on the box and/or on the element and on the power supply.
  - Caution label is to be attached to the junction box.
  - Warning label is to be attached to the service panel.
- For the warranty to be valid refer to Terms and Conditions of Sale and Warranty Registration.

**NOTE:** Leave a copy of all documents referring to the installation of STEP Warmfloor<sup>®</sup> in the service panel at the jobsite.

# POWER SUPPLY

## AC POWER SUPPLY WIRING DIAGRAM

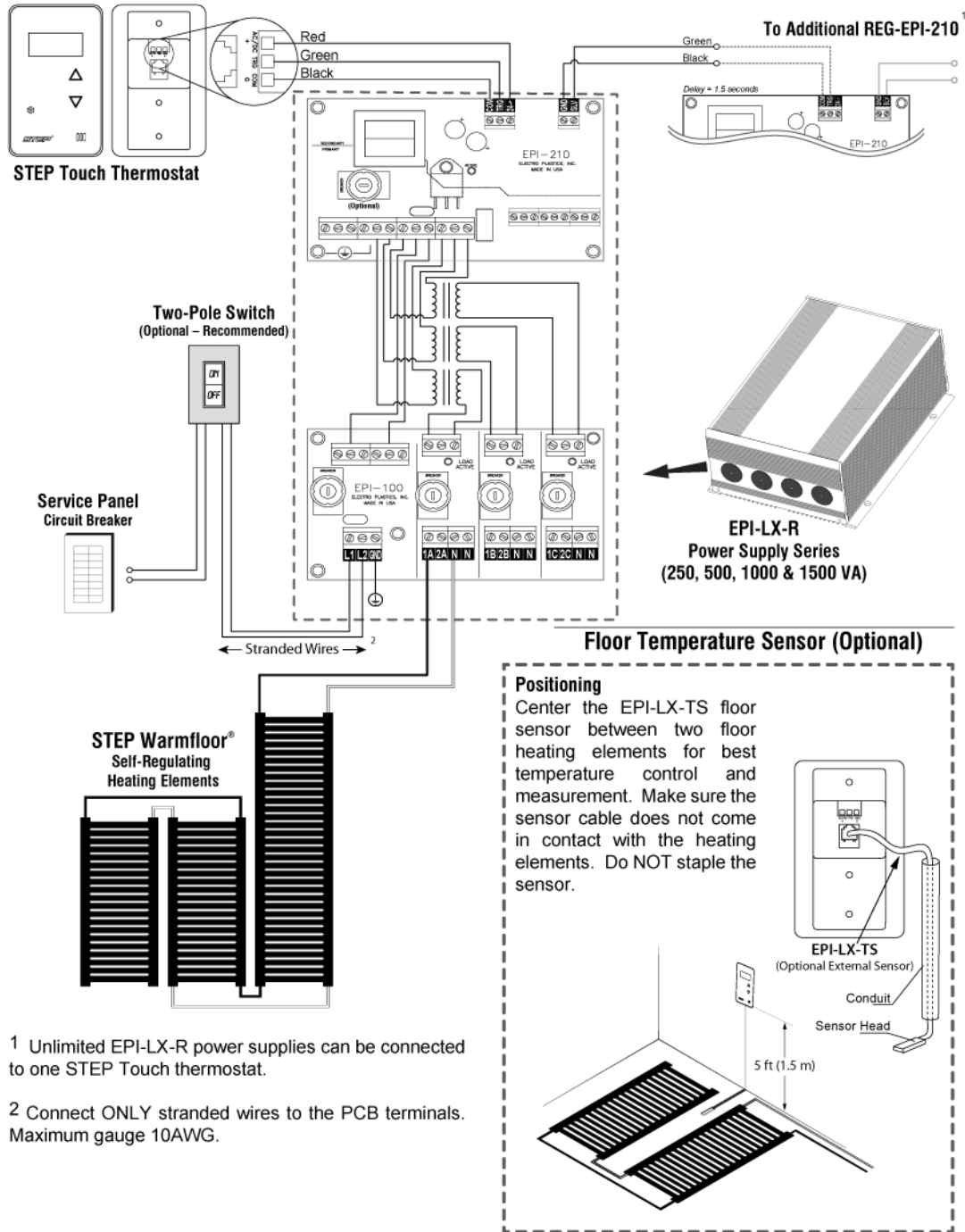



# POWER SUPPLY

## INTERFACE BOARD WIRING DIAGRAM

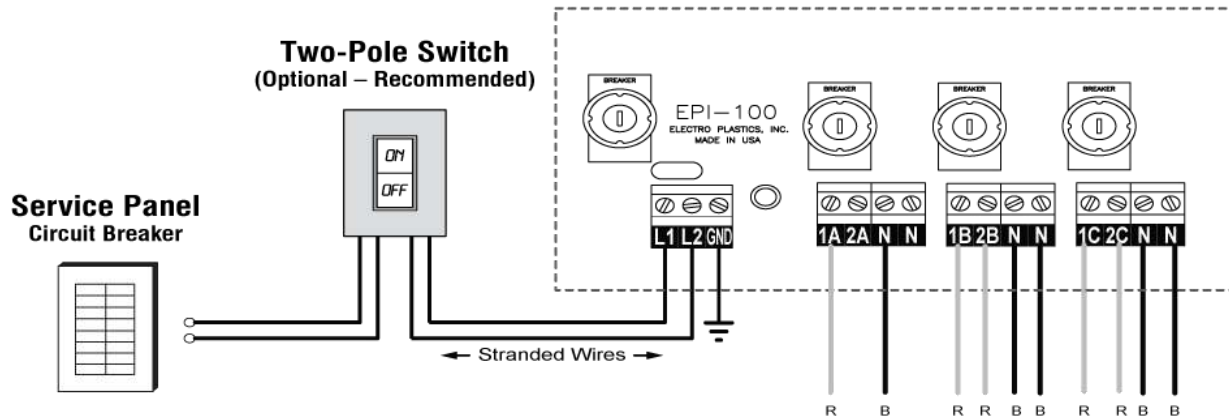

Distribute evenly the load from the elements to each terminal on the secondary circuit breaker. Each terminal can take the following number of wires according to wire gauge:

14 AWG	12 AWG	10 AWG
3	2	1

**NOTE:** Use only stranded wires in the PCB terminals. Inset wires in a straight (rather than twisted fashion for best contact).

**WARNING:** Electronics are delicate devices; make sure you are grounded before touching the PC board. Do not twist or force the terminals and use proper tools to tighten the screws. Tighten with 7 in/Lbf (inch pound force) or 0.8 Nm torque.

PCB EPI-110 and EPI-100 come with one (1) resettable circuit breaker on the primary.

PRIMARY	120 VAC	208 VAC	230 VAC
<b>250W</b>	5A		2.5A
<b>500W</b>	10A	5A	5A
<b>1000W</b>	15A	10A	10A
<b>1500W</b>	20A	15A	15A

PCB EPI-110 has one (1) resettable circuit breaker on the secondary.

SECONDARY	24 VAC
<b>250W</b>	1 x 15A
<b>500W</b>	1 x 25A

PCB EPI-100 can take up to three (3) resettable circuit breakers on the secondary.

SECONDARY	24 VAC
<b>1000W</b>	2 X 25A
<b>1500W</b>	3 X 25A

# POWER SUPPLY

## DC CONTROLLER WIRING DIAGRAM

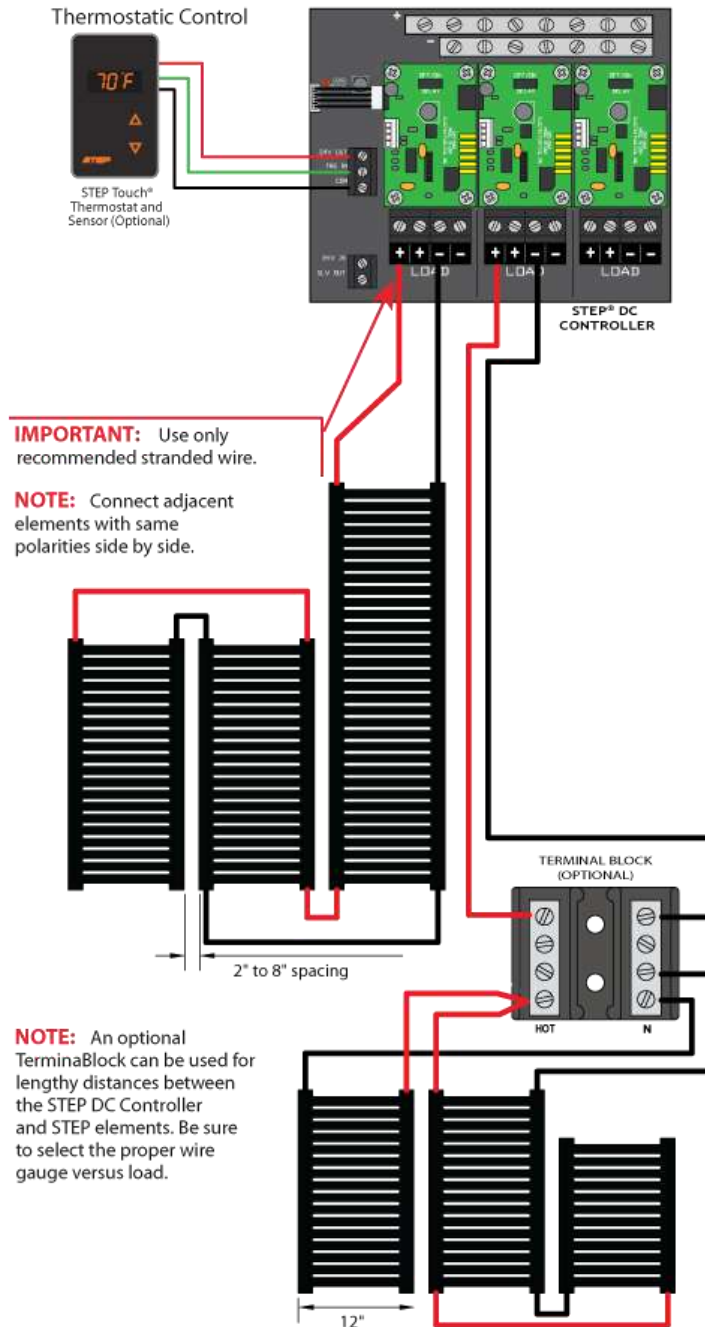

## POWER SUPPLY

### DC CONTROLLER SPECIFICATIONS

The STEP® DC Power Controller's mechanical design is both functional and installation friendly. The compact design is made from extruded aluminum with a sliding cover allowing easy access to all necessary connections. Each channel features a bi-color, illuminated switch for intelligent breaker resetting and indication of the status of the channel.

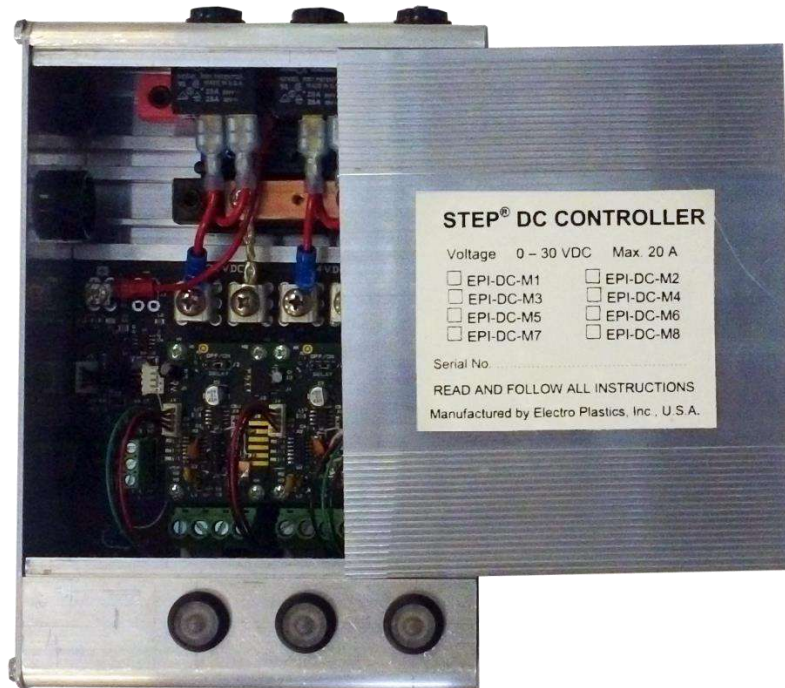

Picture of the DC Controller with one Main PCB and 3 channels (available up to 8 channels)

Each channel in the system is designed to provide power to the attached load in a gentle and controlled manner taking approximately 1 second to softly apply or remove power to the loads.

SPECIFICATION	FUNCTION
Supply Voltage	20-35VDC*
Max Quiescent Current Draw	20mA (500W), 30mA (1000W), 40mA (1500W)
Max Load Current per Channel	20A @ 24VDC
Channel Delay	1 sec (user enabled)
Intelligent Breaker Trip Point	23A & 25A (two stage)
Thermal Breaker	25A

\* The maximum voltage supplied to the controller can be 35VDC, such that when applied to a heating element load a 20A current draw is not exceeded.

## THERMOSTAT AND EXTERNAL SENSOR

The STEP Touch® electronic thermostat is a zone control device which provides a pulsed output that complements the self-regulating nature of the STEP Warmfloor® heating elements.

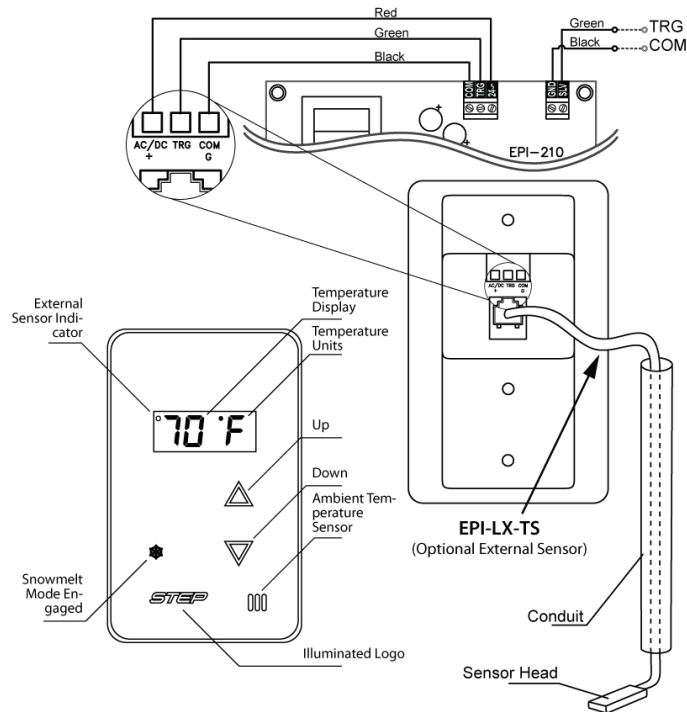

- The thermostat can be used to control the ambient air temperature and/or the floor temperature.
- To control the floor temperature an external sensor is required and has to be installed in the floor between and away from the heating element.
- Use a 3-conductor signal wire (red, green and black) from the thermostat to the AC Power Supply or DC Controller.
- Unlimited power supplies can be connected to one control unit because of the turn on delay of 1.5 seconds between each power supply.

MECHANICAL FEATURES	FUNCTION
External (Front)	3 Digit Auto-Dimmable LED Display (e.g.: 70° F) UP Touch Switch (not membrane switch) DOWN Touch Switch (not membrane switch)
External (Rear)	3 Position Terminal Block (AC/DC, TRG, COM) 6 position 6 Contact Modular Jack
Internal (DIP Switch)	Fahrenheit/Celsius Switch (C/F) Auto Dim Switch (DIM) External Temperature Sensor Mode Switch (EXT) Snowmelt Mode Switch (SM)
Internal Mode Set Temp Range	40° to 90°F / 4° to 32°C
Snow Melt Mode Set Temp Range	32° to 41°F / 0° to 5°C
Power	9-24V AC/DC @ 12mA max

**NOTE:** Refer to the STEP Touch® Installation & Operation Manual.

## FINISH FLOORING

---

### LEVELING AND COVERING THE FLOOR

- Level the floor in accordance with the trade and the manufacturer's instructions, using mortar, mud bed, building boards, underlayment panels, etc. Do not use adhesives or non-approved tapes in direct contact with the elements.
- Codes are revised; new products enter the market and material composition change constantly. It is therefore important to know if these changes comply and/or are compatible with the application.
- Check with the leveling compound and/or building board manufacturer to assure that the material used is appropriate for the given installation.
- To be efficient the heating elements have to be in direct contact with the finished flooring, with no air gaps.
- It is strongly recommended to have thermal insulation under the heating elements.
- Do not place a conductive material in direct contact with the heating elements, i.e., metal mesh, aluminum foil, etc.
- In bathrooms, showers and wet areas, the heating elements shall be installed under a waterproof membrane.
- Respect curing time for concrete, setting materials, grouts, and adhesives before switching on the heating system.
- To condition the site and acclimatize certain floor coverings, it may be necessary to turn the heating system on. Start with a low heat, and progressively raise the supply temperature until it reaches its maximum temperature.
- The first time the system is switched on; it may take some time until the floor gets to the desired temperature.

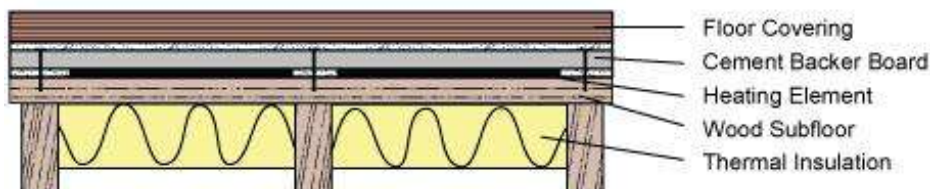
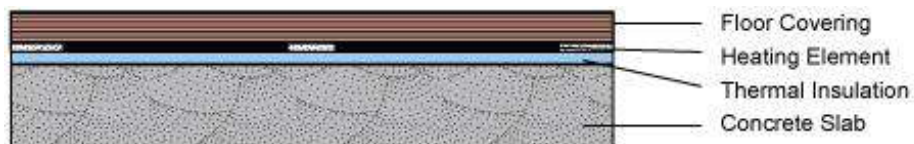

## **WARRANTY REGISTRATION AND COVERAGE**

---

### **LIMITED WARRANTY**

Electro Plastics' limited warranty is valid from date of original purchase, as follows (not included in this warranty are OEM and specialty products):

- 20 years for the STEP Warmfloor® Heating Elements.
- 10 years for the STEP® Snowmelt and STEP Deicing Heating Elements.
- 10 years for the STEP® Transformer Coils in the Power Supplies.
- 3 years for the Interface Electronics in the Power Supplies.
- 3 years for the STEP® Controls

Electro Plastics sole obligation under its warranty shall be, at its option, to either issue a credit for the purchase price, or repair or replace any article or part thereof, which is proved to be other than as warranted. For this warranty to be valid, a copy of the STEP® Labels shall be delivered to ELECTRO PLASTICS, INC., with a diagram indicating to which branch circuit the system is connected, the location of the element strips, the routing of the wires and their different measurements, voltage, amperage, elements and wire length. Electro Plastics warrants the products to be free from defects in material or manufacturing and to perform under normal use. For the warranty to be valid, qualified personnel who are familiar with the construction and operation of the system must install the equipment and a certified electrician has to verify and measure the STEP® elements BEFORE they are covered.

### **Exclusions**

Electro Plastics shall not be responsible for any loss or damage that may arise due to:

- Non-compliance with installation and/or usage of the STEP® elements and accessories as recommended. It shall be Buyer's and End User's duty to read and follow carefully the STEP® Installation Manual. Technical assistance services, e.g. design and layout are to be used as GUIDELINES ONLY, as each application is specific to local conditions and construction
- Dissatisfaction due to improper Installation of the floor covering. All floor covering shall be installed in conformance with the manufacturer's instructions and shall conform to all applicable trade practices, local codes and manufacturer's specifications.
- Usage of inadequate or non-specified materials with the STEP® heating system or products.
- Any and all defects, deficiencies or failures resulting from improper handling of the product; e.g., cuts made to the STEP® elements, or the wires, etc.
- Tampering with the STEP® heating system or products; e.g., removing, altering or overloading the circuit breakers, overcurrent protectors, etc.
- Installation of merchandise with obvious visible defects.

### **How to claim this warranty**

In order to obtain warranty service, Buyer shall return the unit to the dealer from whom the unit was originally purchased, with a dated sales receipt. The dealer will forward the unit to Electro Plastics. Upon receipt of the defective unit, paperwork and explanation of application, Electro Plastics will inspect and test the unit in order to determine the reason for the alleged failure. If it is determined that the unit was properly installed and failed during normal use, as a result of a manufacturing defect, Electro Plastic will repair or replace the unit, or issue a credit or refund of the purchase price, at its sole discretion. The warranty period for any replacement unit will fulfill the warranty of the original unit and will not be extended.



## WARRANTY REGISTRATION AND COVERAGE

### **Limitations**

Under no circumstances will Electro Plastics be liable for labor or other charges related to the installation and use of the STEP® heating system or products. This warranty does not cover labor or removal or reinstallation of the product and is void on any product installed improperly, or in an improper environment, overloaded, misused, abused or altered in any manner. THE WARRANTIES STATED HEREIN ARE EXCLUSIVE OF ALL OTHER WARRANTIES, WRITTEN OR ORAL, STATUTORY EXPRESS OR IMPLIED, INCLUDING ANY WARRANTIES OF MERCHANTABILITY AND FITNESS FOR A PARTICULAR PURPOSE, NONE OF WHICH SHALL APPLY TO THE SALE OF THE COMPANY'S PRODUCTS HEREUNDER. THIS WARRANTY ALSO EXCLUDES INCIDENTAL OR CONSEQUENTIAL DAMAGES FOR BREACH OF ANY WARRANTY ON THE PRODUCTS. Products which are replaced by Electro Plastics in accordance with the foregoing shall become the property of Electro Plastics and shall be returned to it by the purchaser f.o.b. point of shipment. The maximum liability of this warranty is limited to the replacement or repair or purchase price of the defective unit. If a unit is returned and found that no defect exists, or that the user misused the unit, Electro Plastics will inform the user. If the user chooses to have the unit repaired (if possible), labor and shipping charges will apply.

### **Limitation of Liability**

ELECTRO PLASTICS SHALL NOT BE LIABLE FOR ANY LOSS, CLAIM, EXPENSE OR DAMAGE CAUSED BY, CONTRIBUTED TO OR ARISING OUT OF THE ACTS OR OMISSIONS OF BUYER OR THIRD PARTIES, WHETHER NEGLIGENT OR OTHERWISE, IN NO EVENT SHALL ELECTRO PLASTICS' LIABILITY FOR ANY CAUSE OF ACTION WHATSOEVER EXCEED THE COST OF THE PRODUCT GIVING RISE TO THE CLAIM, WHETHER BASED IN CONTRACT, WARRANTY, INDEMNITY OR TORT (INCLUDING NEGLIGENCE AND STRICT LIABILITY) OR OTHERWISE. IN NO EVENT SHALL ELECTRO PLASTICS BE LIABLE OR ANY SPECIAL, INCIDENTAL, CONSEQUENTIAL OR OTHER SUCH INDIRECT DAMAGES (INCLUDING, WITH-OUT LIMITATION, LOSS OF REVENUES, PROFITS OR OPPORTUNITIES), WHETHER ARISING OUT OF OR AS A RESULT OF BREACH OF CONTRACT, WARRANTY, TORT (INCLUDING NEGLIGENCE), STRICT LIABILITY OR OTHERWISE.

### WARRANTY REGISTRATION CARD

Ref. No. ....

#### **CUSTOMER INFORMATION**

Owner's Name \_\_\_\_\_

Address \_\_\_\_\_

City / State / Zip \_\_\_\_\_

Phone \_\_\_\_\_

Email \_\_\_\_\_

#### **PURCHASE AND PROJECT INFORMATION**

Purchased From \_\_\_\_\_ Date \_\_\_\_\_

Address \_\_\_\_\_

Product Purchased:  Floor Heating  
 Snowmelt  
 Roof Deicing

Heating Elements Installed in :  Bathroom  Kitchen  
 Basement  Other

Heating Elements Installed under:  Tile/Stone  Carpet  
 Hardwood  Laminate  
 Between joists  Other

Type of Project:  New Construction  
 Renovation Project

To activate warranty complete and return this warranty registration card signed with a complete checklist and layout showing element distribution as installed to: 11147 Dorsett Road, Maryland Heights, MO 63043, U.S.A.



# WARRANTY REGISTRATION AND COVERAGE

## CHECK LIST

Ref. No. .... Page ..... of .....

STEP Touch Thermostat:     EPI-LX-TC     Black     White    External Sensor     EPI-LX-TS

AC Power Supply Model No.:    EPI-LX-.....-.....W     120V     208V     230V    50/60Hz

STEP® Element Model No. :    MEP-.....-.....W-24V

Total Length Installed :    ..... Linear Feet

### MEASUREMENT INSTRUCTIONS

Measure primary and secondary volts and amps at the transformer terminals. One sheet per transformer.

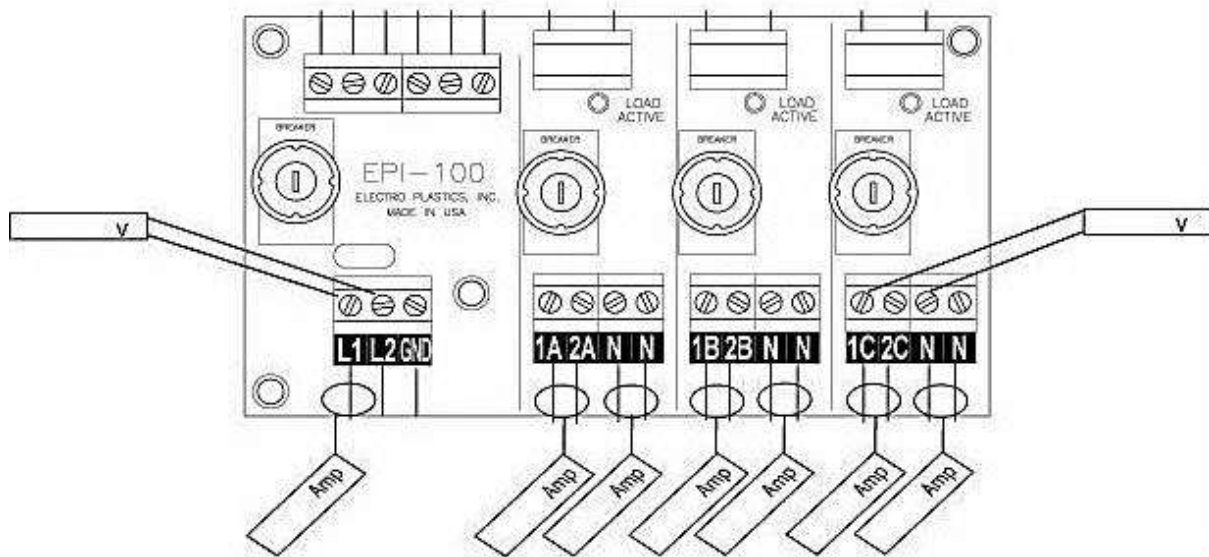

Installed / measured by:

Date:

\_\_\_\_\_  
Name

\_\_\_\_\_  
Signature

# WARRANTY REGISTRATION AND COVERAGE

## CHECK LIST

Ref. No. .... Page ..... of .....

STEP Touch Thermostat:     EPI-LX-TC     Black     White    External Sensor     EPI-LX-TS

DC Controller Model No.:             EPI-DC-M1     EPI-DC-M2     EPI-DC-M3     EPI-DC-M4  
     EPI-DC-M5     EPI-DC-M6     EPI-DC-M7     EPI-DC-M8

STEP® Element Model No. :        MEP-.....-.....W-24V

Total Length Installed :            ..... Linear Feet

### MEASUREMENT INSTRUCTIONS

Measure input and output volts and amps at the DC controller terminals.

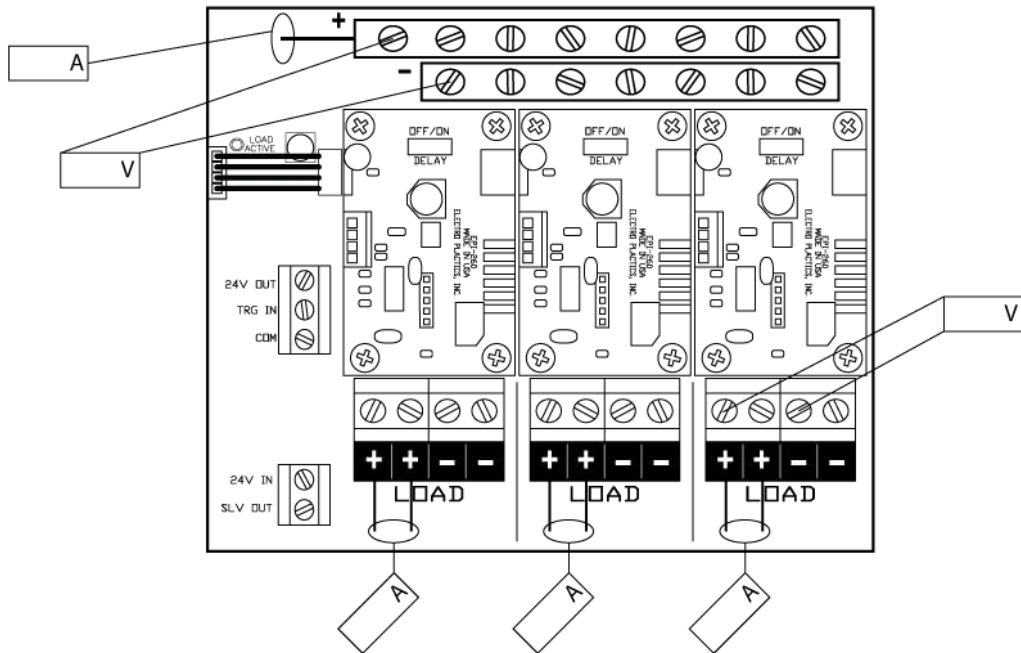

Installed / measured by:

Date:

\_\_\_\_\_

Name

\_\_\_\_\_

Signature

## **TROUBLESHOOTING**

---

If the following procedures do not solve and relieve the problems encountered, please check with our Technical Service Department.

### **POWER SUPPLY**

#### **Problem:**

**1. Power Supply or DC Controller will not start:**

- a) No current**
- b) Current is present**
- c) PC board in AC Power Supply or DC Controller has current**
- d) Thermostat**

#### **Solution:**

- Reset circuit breaker in service panel and switch on line voltage branch circuit.
- Reset mini circuit breaker in power supply, push plunger in until it stays in.
- Make sure the thermostat settings are correct and that the thermostat calls for heat. Set the temperature to maximum and wait a couple of minutes for the system to turn on.
- Bypass thermostat by disconnecting the thermostat cable from PCB (printed circuit board) and put a jump wire from terminal TRG to 24. The active load should now be lit and the system is on. The fault is in the thermostat cable or its connections.

**2. Power Supply becomes hot:**

- a) Poor ventilation**
- b) High voltage conditions**
- c) High ambient temperature**

- Power Supply should be mounted vertical for the cooling fins to extract heat from the enclosure and it must be placed in a well-ventilated area.
- A technician can rewire 120V or 208V transformers to accept higher voltage. Contact customer service for guidance.
- Power supply must be de-rated; decrease load.

**3. Electrical shock in wet areas:**

- a) No or disconnected grounding**
- b) Potential Difference**

- Make sure that all plumbing (e.g. pipes, faucets and drains) are connected to ground to divert electrical charge.
- Have a certified electrician test which equipment is causing electrical shock and make sure that all plumbing is connected to the same grounding system.

# **TROUBLESHOOTING**

---

## **HEATING ELEMENTS**

### **Problem:**

#### **1. Insufficient temperature:**

- a)** Thermostat setting
- b)** Cold spots on the floor
- c)** Warm spots on the floor
- d)** Hot spots on the floor
- e)** Low supply voltage
- f)** No heating

### **Solution:**

- Set temperature to desired level and leave it on day and night. This is the best energy saving mode. Temperature will build up in walls, floor and ceiling and the self-regulating heating elements will effortlessly maintain a warm comfortable environment.
- The most common cause is lack of insulation, humid or wet insulation or an air gap between flooring layers.
- Cold strips are also noticed between elements if they are spaced out too far.
- Hot water tubing and hot air ducts, etc., would contribute to warmer spots. STEP<sup>®</sup> heating elements are self-regulating and cannot overheat by themselves.
- Make sure that the element strips are not touching each other. Check that the current on the element strips that are side by side have the same polarity.
- Some regions or locations may have a low supply voltage and some may take electricity from sub-panels with reduced voltage. This results in a proportionally lower heat output. It is possible to boost up the voltage so the elements can give more heat but this requires engineering.
- With the system on, measure the voltage and amperage; if that is not possible, disconnect the system and measure the ohms. Find out the materials used for the installation, including adhesives, tapes, membranes and carpet cushions. Some materials are not recommended for over radiant heat and may produce harmful off-gazing. Check with manufacturer.

Stonestreet Distribution is a master distributor of STEP Warmfloor  
www.ThePerfectHeat.com • Sales@StoneStreetCorp.com • 401-433-6900



#### APPROVALS AND CERTIFICATIONS



UL 1693 3<sup>rd</sup> Edition  
UL 5085-1 & 2  
CSA-C22.2 No.130-16  
CSA-C22.2 No. 66.1 & 2-06



EN 60355-2-96-2009  
EN 61558-2-2:2007

---